



Specially designed surfaces to protect document storage

Whichever configuration you choose from this easy order document shelving, will be finished to the highest standards.

Part of its design is to include neat rolled front edges. This allows for the safe and comfortable retrieval of files and documents from the bays without damage.

Each centre shelf is adjustable allowing you to make the most of available space easily. Document shelving is ideal to store archive material and 'good looking enough' to be accepted in any busy office. The powder coated finish together with the quality of manufacture ensure that you will receive a product that will stand up to all the rigours of any mainstream office environment.

There are many extra options that can be added to the system.

Many large companies and Government departments specify this type of shelving as it is comfortable to work with and safe and easy to extend as their requirements change. You can either buy the simple bays (shown opposite) or - if you have a larger or more complicated requirement our technical advisors will be happy to visit you on site.

A simple yet very effective design creates a highly efficient storage facility to complement any office.

The system includes a combination of fixed and adjustable shelf storage levels that can be specified as either ...

- **Open bays ...**

as shown here - which include the solid endframes with a simple rear bracing at the back of the bay - often used for larger files of archive boxes or;

- **Closed bays ...**

which are supplied with a sheet steel back, used generally for the smaller items which may be displaced off the shelf.

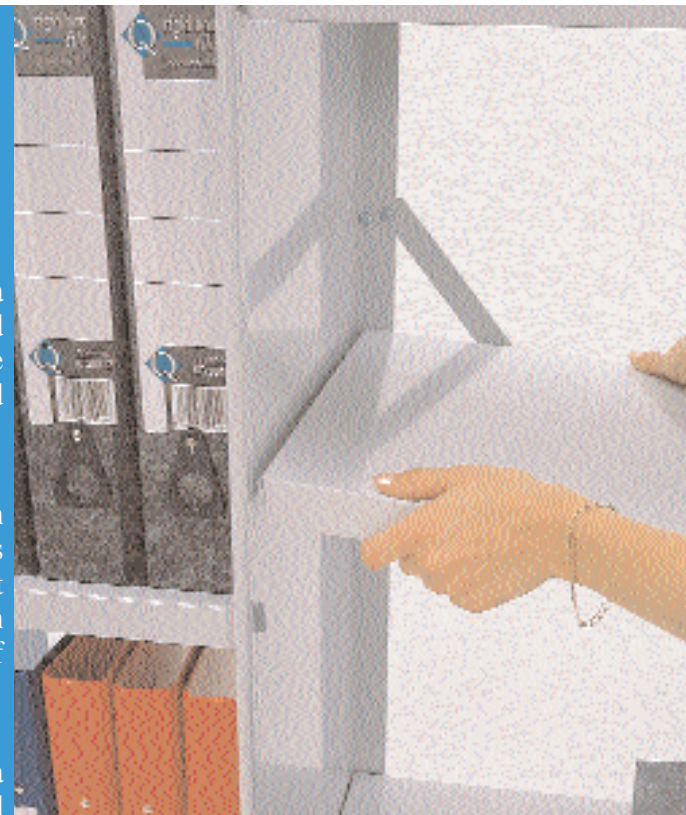

Easy to adjust
easy to add to ...

Easy order adjustable office shelving

Everything you need in one easy order ...

All bays come complete with six shelves and fittings. The centre four shelves are fully adjustable.

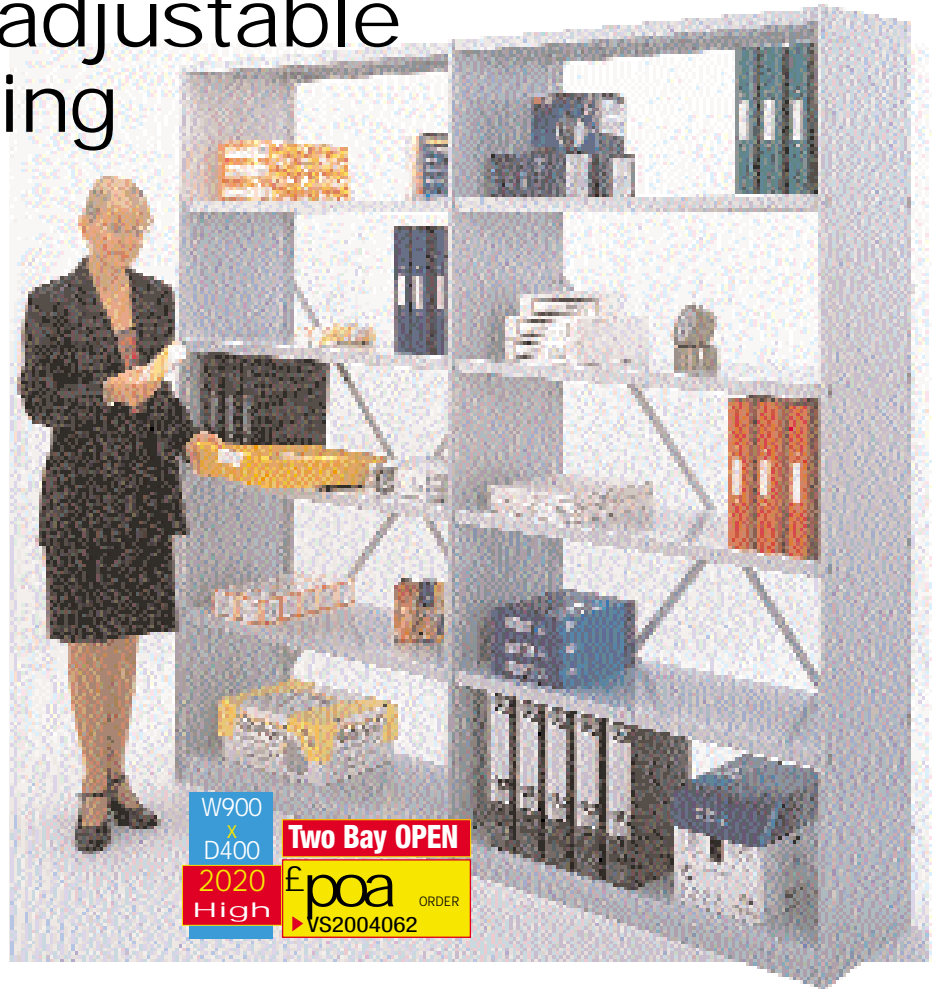
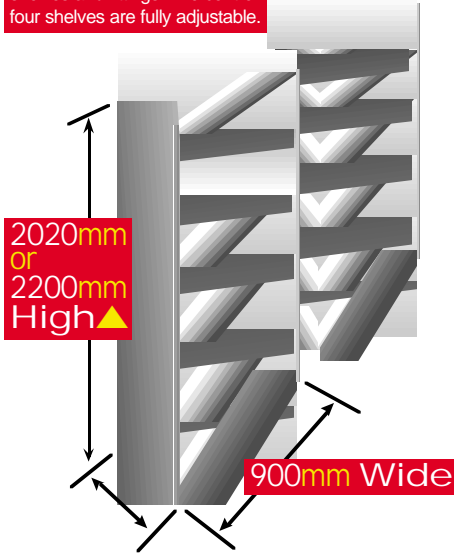

Uprights • 6 shelves • base plinth • bracing • clips and all fittings in one order number

Includes Six shelf levels	▼ 2020mm High OPEN BAYS ▼			▼ 2200mm High OPEN BAYS ▼			
	300mm DEEP	400mm DEEP	450mm DEEP	300mm DEEP	400mm DEEP	450mm DEEP	
1 BAY	£ poa ORDER VS2003061	£ poa ORDER VS2004061	£ poa ORDER VS2004561	1 BAY	£ poa ORDER VS2203061	£ poa ORDER VS2204061	£ poa ORDER VS2204561
2 BAYS	£ poa ORDER VS2003062	£ poa ORDER VS2004062	£ poa ORDER VS2004562	2 BAYS	£ poa ORDER VS2203062	£ poa ORDER VS2204062	£ poa ORDER VS2204562
3 BAYS	£ poa ORDER VS2003063	£ poa ORDER VS2004063	£ poa ORDER VS2004563	3 BAYS	£ poa ORDER VS2203063	£ poa ORDER VS2204063	£ poa ORDER VS2204563
4 BAYS	£ poa ORDER VS2003064	£ poa ORDER VS2004064	£ poa ORDER VS2004564	4 BAYS	£ poa ORDER VS2203064	£ poa ORDER VS2204064	£ poa ORDER VS2204564
5 BAYS	£ poa ORDER VS2003065	£ poa ORDER VS2004065	£ poa ORDER VS2004565	5 BAYS	£ poa ORDER VS2203065	£ poa ORDER VS2204065	£ poa ORDER VS2204565

Includes Six shelf levels	▼ 2020mm High CLOSED BAYS ▼			▼ 2200mm High CLOSED BAYS ▼			
	300mm DEEP	400mm DEEP	450mm DEEP	300mm DEEP	400mm DEEP	450mm DEEP	
1 BAY	£ poa ORDER VS20C3061	£ poa ORDER VS20C4061	£ poa ORDER VS20C4561	1 BAY	£ poa ORDER VS22C3061	£ poa ORDER VS22C4061	£ poa ORDER VS22C4561
2 BAYS	£ poa ORDER VS20C3062	£ poa ORDER VS20C4062	£ poa ORDER VS20C4562	2 BAYS	£ poa ORDER VS22C3062	£ poa ORDER VS22C4062	£ poa ORDER VS22C4562
3 BAYS	£ poa ORDER VS20C3063	£ poa ORDER VS20C4063	£ poa ORDER VS20C4563	3 BAYS	£ poa ORDER VS22C3063	£ poa ORDER VS22C4063	£ poa ORDER VS22C4563
4 BAYS	£ poa ORDER VS20C3064	£ poa ORDER VS20C4064	£ poa ORDER VS20C4564	4 BAYS	£ poa ORDER VS22C3064	£ poa ORDER VS22C4064	£ poa ORDER VS22C4564
5 BAYS	£ poa ORDER VS20C3065	£ poa ORDER VS20C4065	£ poa ORDER VS20C4565	5 BAYS	£ poa ORDER VS22C3065	£ poa ORDER VS22C4065	£ poa ORDER VS22C4565

Extra shelves including clips • 300mm Deep VDS3090 - £poa each • 400mm Deep VDS4090 - £poa each • 450mm Deep VDS4590 - £poa each

Mobile shelving

Why not let us show you how to create up to 50% extra storage space



Electronically operated longspan shelving ...



Archive document storage ...

All of the shelving systems that we have shown to you in Storage Direct are suitable for mounting onto mobile bases!

Static shelving relies on separate aisles to enable access to stored items - however, with mobile shelving, you only need one aisle for access to the shelf locations. By mounting the shelving units on a steel mobile base system, which run on floor tracks, the units can be opened and closed as required. So, in effect, one aisle does the work of several and this results in the overall storage capacity being increased - freeing valuable space for other uses - also, the closed aisles bring added security to stored items. Mobile bases will fit to most new or existing bays of shelving.

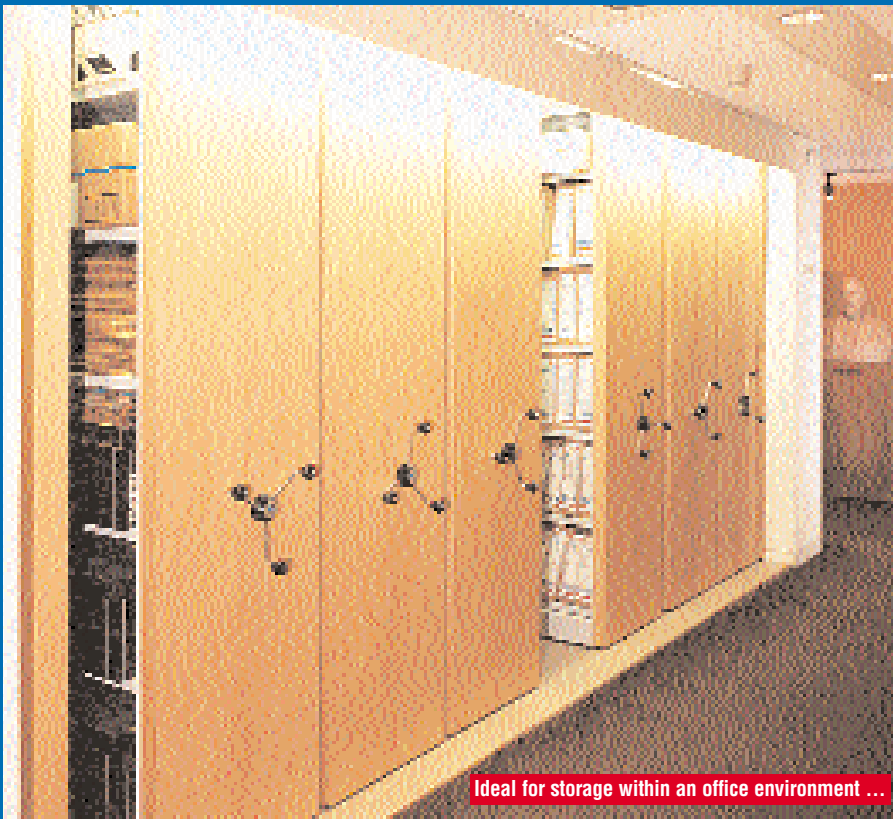

Ideal for storage within an office environment ...

Use mobile shelving, and you'll get up to 10 bays into far less space than 5 static shelving bays. Mobile shelving means floorspace costs can be cut dramatically, along with the other costs such as heating, lighting, and general building maintenance.

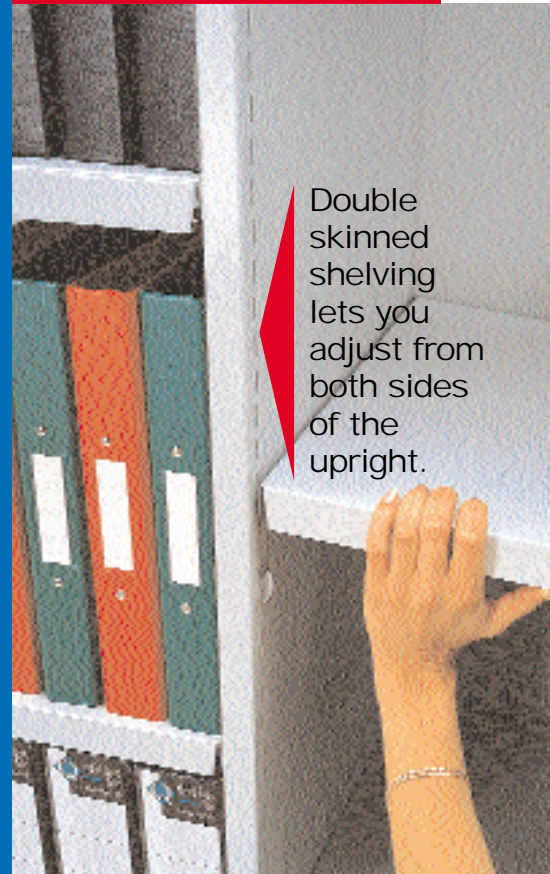

Double skinned shelving lets you adjust from both sides of the upright.

Storage Direct

for all the storage systems you need in your office



The difference between single and double skinned shelving is quite subtle - yet often very important



If you compare the double skin shelving shown here with the single on the previous page, you will notice very little difference between the two. Indeed the styles are very similar and the shelves are the same, however it's the uprights that make all the difference between the two systems.

Both types of shelving are fully adjustable however the single skin uses a common clip that accepts the shelf. This protrudes through the upright and although not essential, is often used to support the shelf in the adjacent bay. In any case the clip does protrude into the next bay that can in certain circumstances

mean that space is wasted or important files can be marked.

This option often makes absolutely no difference to many users. However, the alternative is to have these better looking double skinned bays, that take shelf clips from both sides without any wasted space.

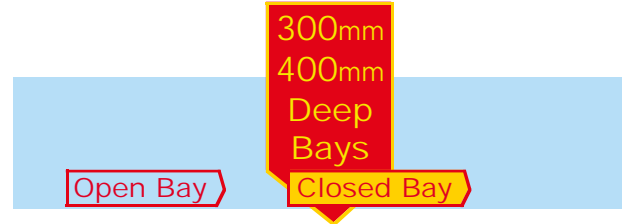

Bay Loading 448kg

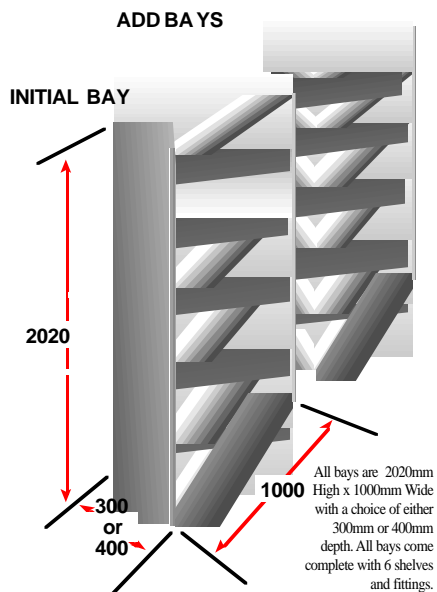

All bays are supplied complete with 6 shelves and all fittings

Number of Bays	OPEN BAYS		CLOSED BAYS	
	300mm Deep	400mm Deep	300mm Deep	400mm Deep
1	£ poa ORDER ▶ VSEDBO361	£ poa ORDER ▶ VSEDBO461	£ poa ORDER ▶ VSEDBC361	£ poa ORDER ▶ VSEDBC461
2	£ poa ORDER ▶ VSEDBO362	£ poa ORDER ▶ VSEDBO462	£ poa ORDER ▶ VSEDBC362	£ poa ORDER ▶ VSEDBC462
3	£ poa ORDER ▶ VSEDBO363	£ poa ORDER ▶ VSEDBO463	£ poa ORDER ▶ VSEDBC363	£ poa ORDER ▶ VSEDBC463
4	£ poa ORDER ▶ VSEDBO364	£ poa ORDER ▶ VSEDBO464	£ poa ORDER ▶ VSEDBC364	£ poa ORDER ▶ VSEDBC464
5	£ poa ORDER ▶ VSEDBO365	£ poa ORDER ▶ VSEDBO465	£ poa ORDER ▶ VSEDBC365	£ poa ORDER ▶ VSEDBC465

Uprights • 6 shelves • base plinth • bracing • clips and all fittings in one order number

allow
unhindered access to your storage

Tambour Cupboard
1651H x 1000W x 457D

Total filing capacity 4.2 metres

Tambour Cupboard 1651 x 1000 x 457
ONLY
£ poa
ORDER ▶ VST65GG

Tambour Cupboard 1981 x 1000 x 457
ONLY
£ poa
ORDER ▶ VST78GG

Tambour Cupboard
1981H x 1000W x 457D

Total filing capacity 5.1 metres

Tambour Cupboard
1016H x 1000W x 457D

Total filing capacity 2.6 metres

Tambour Cupboard 1016 x 1000 x 457
ONLY
£ poa
ORDER ▶ VST40GG

Tambour Cupboard
711H x 1000W x 457D

Total filing capacity 1.7 metres

Tambour Cupboard 711 x 1000 x 457
ONLY
£ poa
ORDER ▶ VST28GG



Each tambour cupboard incorporates sliding doors that fully retract into the cupboard sides. This means that you get full access to view your files whilst at the same time not taking up any wasteful aisle space with doors.

They are sturdy, extremely good looking - and an efficient addition to any office. Each of the tambour cupboards is delivered fully assembled and empty allowing you to fit any of the accessories shown below ▼

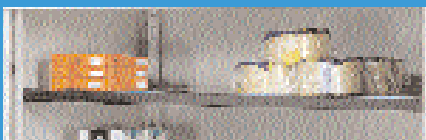

Basic shelf + clips
915mm wide
£ poa each
ORDER ▶ VBBS



Roll out shelf pack
915mm wide
£ poa each
ORDER ▶ VBRS



Filing frames will accept vertical files in two directions. We suggest that no more than one roll out lateral file frame is used per cupboard and placed towards the base of the unit.



Slotted shelf + clips
915mm wide
£ poa each
ORDER ▶ VBSS

Dividers for above
Pk 5 -150mm high
£ poa 5 pack
ORDER ▶ VBSPK05



Pigeon hole fitting
915mm wide
£ poa complete
ORDER ▶ VBPH



Static lateral frame
915mm wide
£ poa each
ORDER ▶ VBUR

Roll out lateral frame
£ poa complete
ORDER ▶ VBRF



Price includes 3 shelves

DIRECT ONLY £poa ORDER ▶ V6536/2

DIRECT ONLY £poa ORDER ▶ V7236/2

Price includes 3 shelves

Security Cupboard 1651H x 915W x 460D

Price includes 1 shelf

Security Cupboard 1828H x 915W x 460D

Security Cupboard 1016H x 915W x 460D

DIRECT ONLY £poa ORDER ▶ V4036/2

Filing and storage around the office

Security cupboards ...

Strong, robust Office cupboards to create inexpensive and secure storage. To many people - not quite as versatile or good looking as our tambour cupboard range shown opposite, however the strong two point lock together with steel doors and a sturdy frame, often makes this cupboard a more suitable answer to your storage requirements, particularly if its security you need. A combination of the two are often used.

Supplied complete with either one shelf in the smaller cupboard or three shelves in the taller options.

All cupboards are supplied complete so there is no awkward 'on site' assembly.



4 Drawer Cabinet 1322H x 470W x 620D

3 Drawer Cabinet 1016H x 470W x 620D

2 Drawer Cabinet 710H x 470W x 620D

DIRECT ONLY £poa ORDER ▶ VBS4EGG

DIRECT ONLY £poa ORDER ▶ VBS3EGG

DIRECT ONLY £poa ORDER ▶ VBS2EGG

Been a good filing cabinet system, you know you've had a primary one comes down to the life that you can expect from it

The features that go into making a good filing cabinet system can only be judged after it has performed the duties and rigours of a busy office over a number of years.

Shown here is the most popular filing cabinet system available ...

They are strong - well made, and use only the best quality fittings, to provide you with many years of hassle free filing. Each cabinet includes an inbuilt anti-tilt device for added safety and each unit is tested to BS5459 part 3.

They are supplied ready assembled in powder coated light grey to fit in with all office colour schemes.

Each drawer has a handy clip on identity label and two keys are supplied from a 200 series range (master keys available).

VALUE Range of Office Storage

High Quality at a **LOWER COST!**



VALUE Filing Cabinets

- Access to whole drawer
- Textured Paint Finish
- Smooth ball bearings
- Available in Goose Grey only
- Fully welded carcass
- Positive drawer closing
- Anti-tilt safety device
- Locking

VALUE Tambour Cupboards

Description	Order ▼	Price £
Basic Shelf	VBBS	poa
Roll-out Shelf	VBRS	poa
Slotted Shelf	VBSS	poa
6" Shelf Divider (pk5)	VBSDPK05	poa
Static Lateral Frame (915mm)	VBUR	poa
Pigeon Hole Fitting	VBPH	poa
Roll-out Lateral Frame	VBRF	poa



H1016 x W1000 x D457
 DIRECT ONLY
£poa
 ORDER ▶ VCST40GG



H1651 x W1000 x D457
 DIRECT ONLY
£poa
 ORDER ▶ VCST65GG



H1968 x W1000 x D457
 DIRECT ONLY
£poa
 ORDER ▶ VCST78GG

any of the accessories detailed above.